



**THE AUSTRALIAN
TRELLIS DOOR CO.**

The Australian Trellis Door Company

ABN: 82 003 946 432

A6 / 366 Edgar Street

Condell Park NSW 2200

Tel: 1300 838 259

Fax: (02) 8723 2899

Email: trellis@trellisdoors.com

Web: www.trellisdoors.com.au

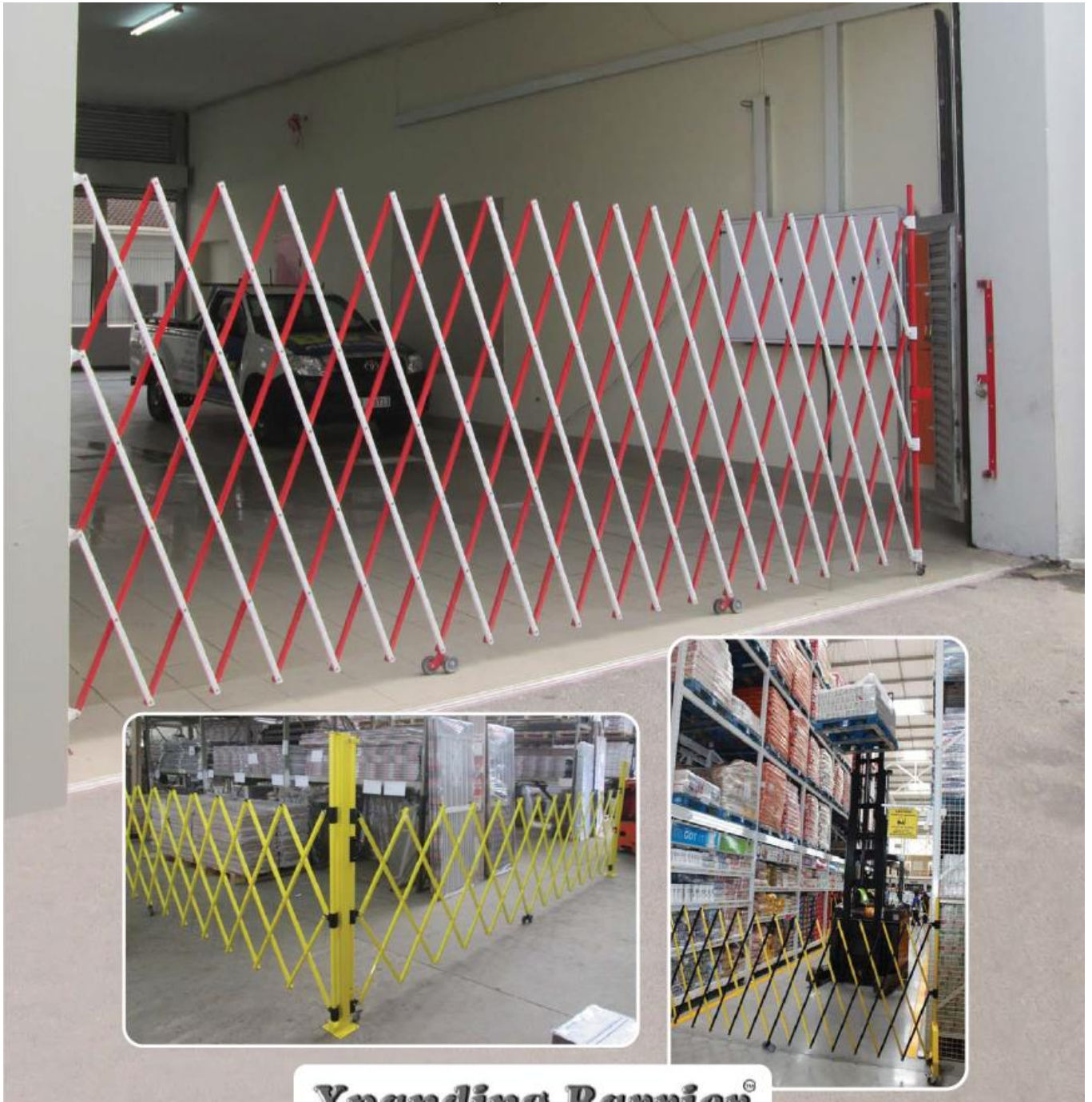

Xpanding Barrier[®]

Complete solution to access control

Xpanding Barrier®

DIFFERENT HEIGHTS

3m x 1.2m Xpanding Barrier system

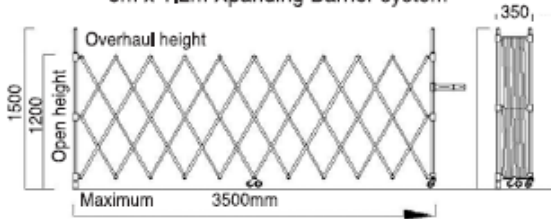

3m x 1.8m Xpanding Barrier system

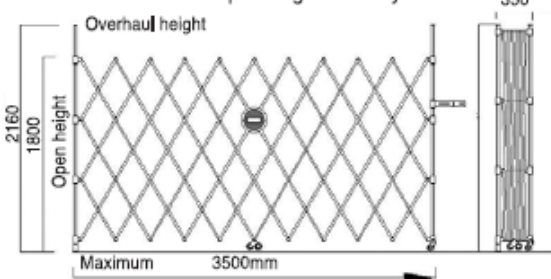

SUPPORT POSTS

No walls needed: Can go in any direction & for any length

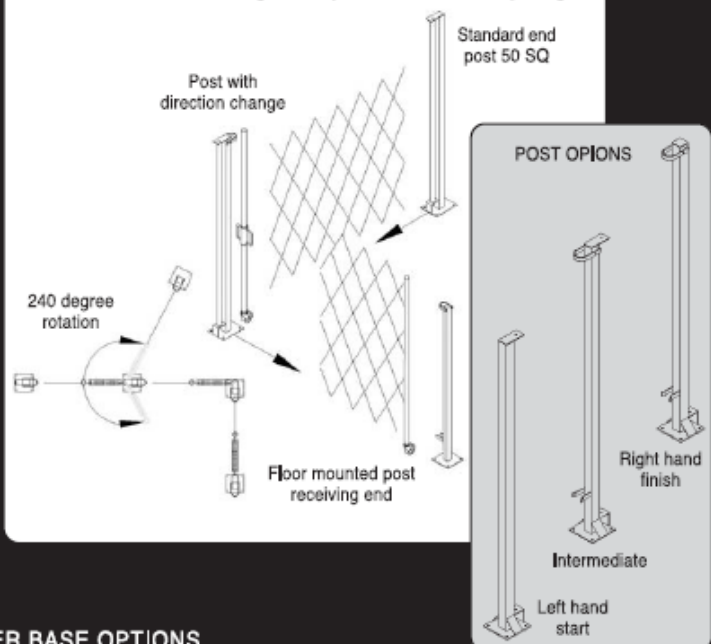

BARRIER BASE OPTIONS

Wall mounted

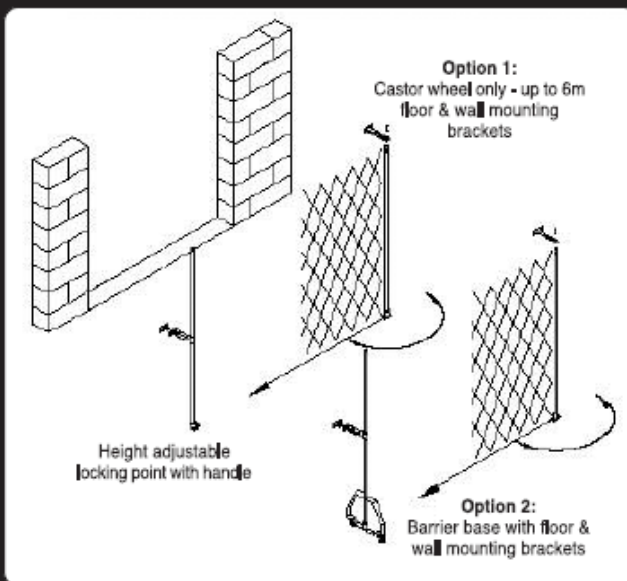

Free standing

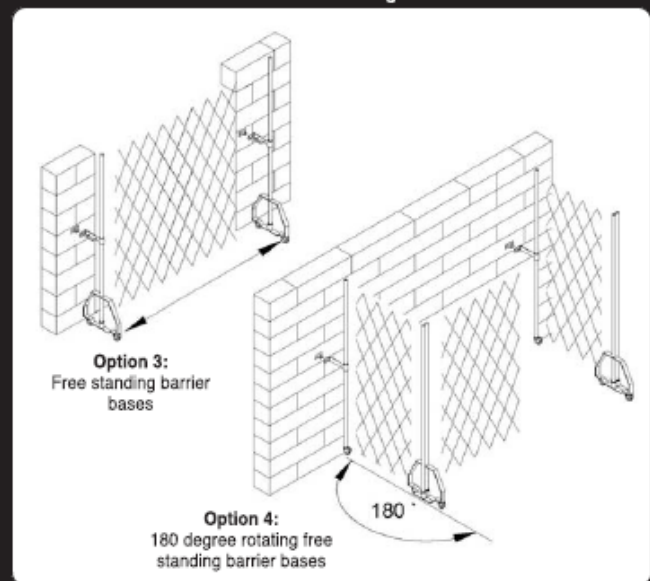

- ✓ Enhances access control on Roller Shutter Doors, Business Entrances/Exits
- ✓ Promotes Health & Safety in the work place or retail environment when access control is required
- ✓ Light weight aluminium construction for easy maneuverability & easy to store
- ✓ Comes in a range of width options (1m - 8m) & finished heights (1.2m or 1.8m)

Security Trackless Diamond Barrier Systems

1 Meter Trackless Diamond Barrier System

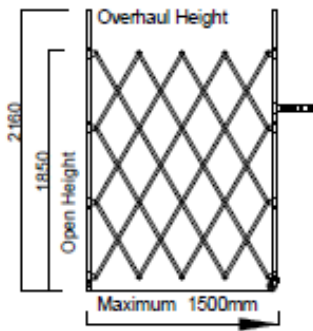

Stack Width & Weight



29 Kg's

Trackless Diamond Barrier System Leading edge options

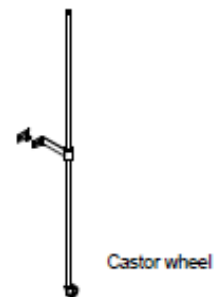

2 Meter Trackless Diamond Barrier System

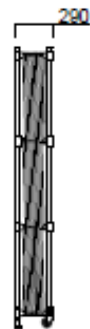
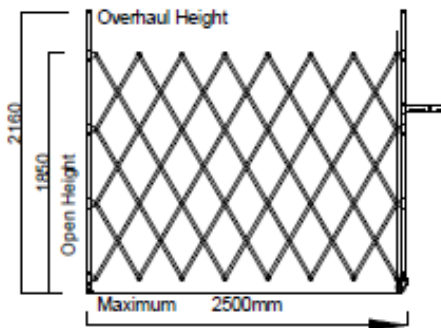

33 Kg's



3 Meter Trackless Diamond Barrier System

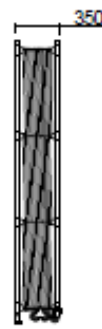
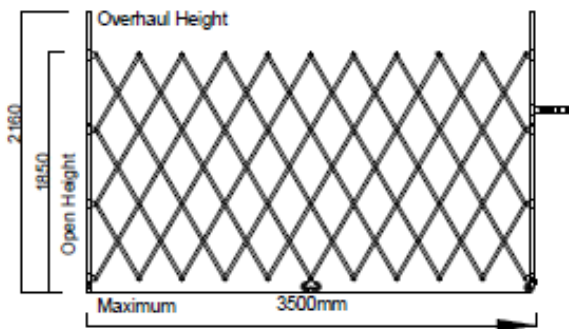

36 Kg's

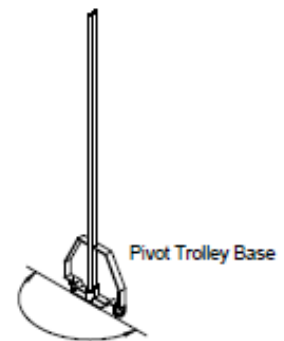

4 Meter Trackless Diamond Barrier System

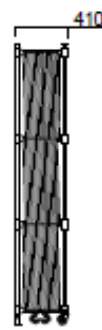
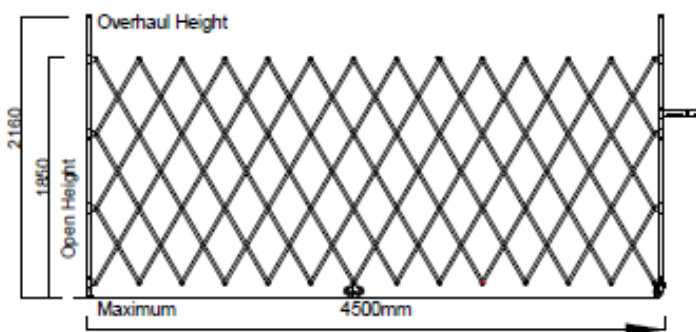

40 Kg's

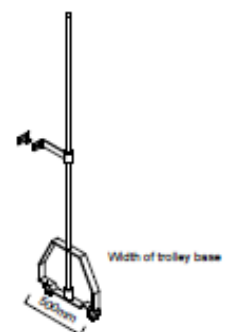

Security Trackless Diamond Barrier Systems

5 Meter Trackless Diamond Barrier System

Stack Width & Weight

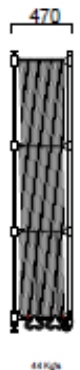
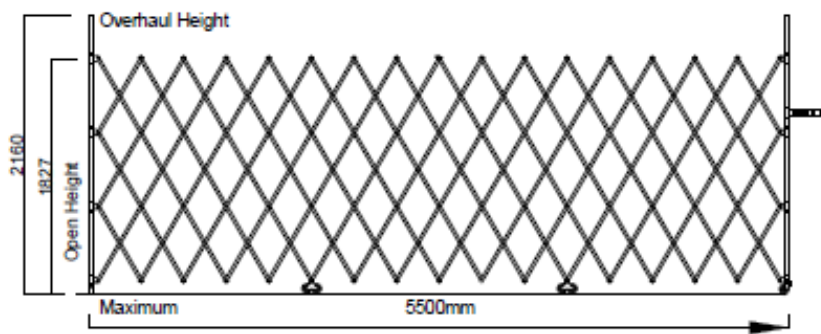

6 Meter Trackless Diamond Barrier System

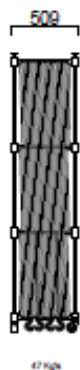
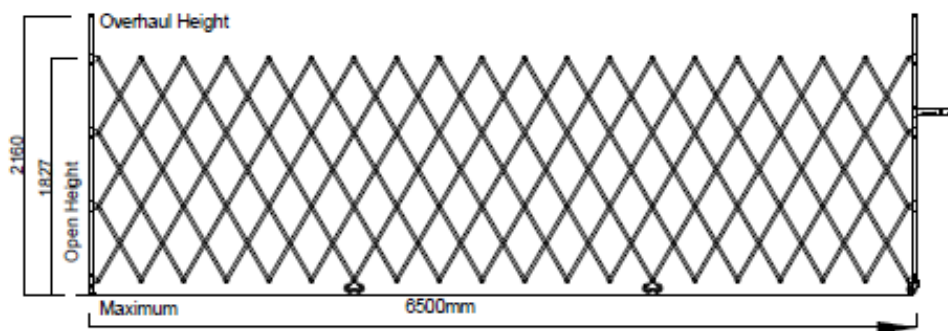

7 Meter Trackless Diamond Barrier System

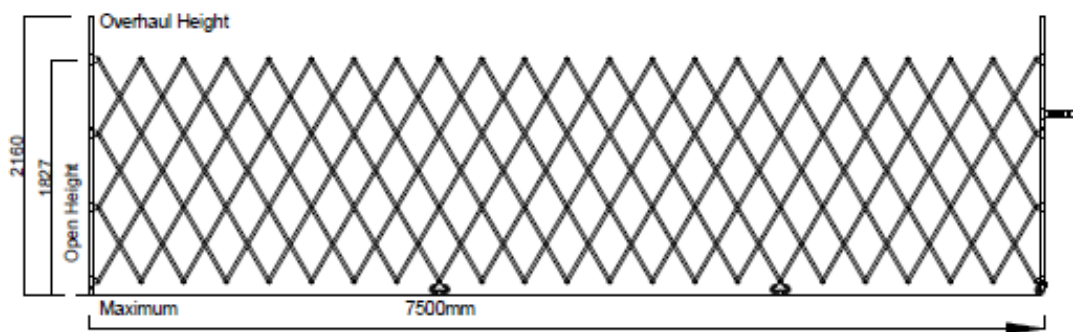

8 Meter Trackless Diamond Barrier System

